

Noise Considerations for Integrated Pressure Sensors

Prepared by Ador Reodique, Sensor and Systems Applications Engineering and Warren Schultz, Field Engineering

INTRODUCTION

Motorola Integrated Pressure Sensors (IPS) have trimmed outputs, built-in temperature compensation and an amplified single-ended output which make them compatible with Analog to Digital converters (A/D's) on low cost micro-controllers. Although 8-bit A/D's are most common, higher resolution A/D's are becoming increasingly available. With these higher resolution A/D's, the noise that is inherent to piezo-resistive bridges becomes a design consideration.

The two dominant types of noise in a piezo-resistive integrated pressure sensor are shot (white) noise and 1/f (flicker noise). Shot noise is the result of non-uniform flow of carriers across a junction and is independent of temperature. The second, 1/f, results from crystal defects and also due to wafer processing. This noise is proportional to the inverse of frequency and is more dominant at lower frequencies³.

Noise can also come from external circuits. In a sensor system, power supply, grounding and PCB layout is important and needs special consideration.

The following discussion presents simple techniques for mitigating these noise signals, and achieving excellent results with high resolution A/D converters.

EFFECTS OF NOISE IN SENSOR SYSTEM

The transducer bridge produces a very small differential voltage in the millivolt range. The on-chip differential amplifier amplifies, level shifts and translates this voltage to a single-ended output of typically 0.2 volts to 4.7 volts. Although the transducer has a mechanical response of about 500 Hz, its noise output extends from 500 Hz to 1 MHz. This noise is amplified and shows up at the output as depicted in Figure 1.

There is enough noise here to affect 1 count on an 8 bit A/D, and 4 or 5 counts on a 10 bit A/D. It is therefore important to consider filtering. Filtering options are discussed as follows.

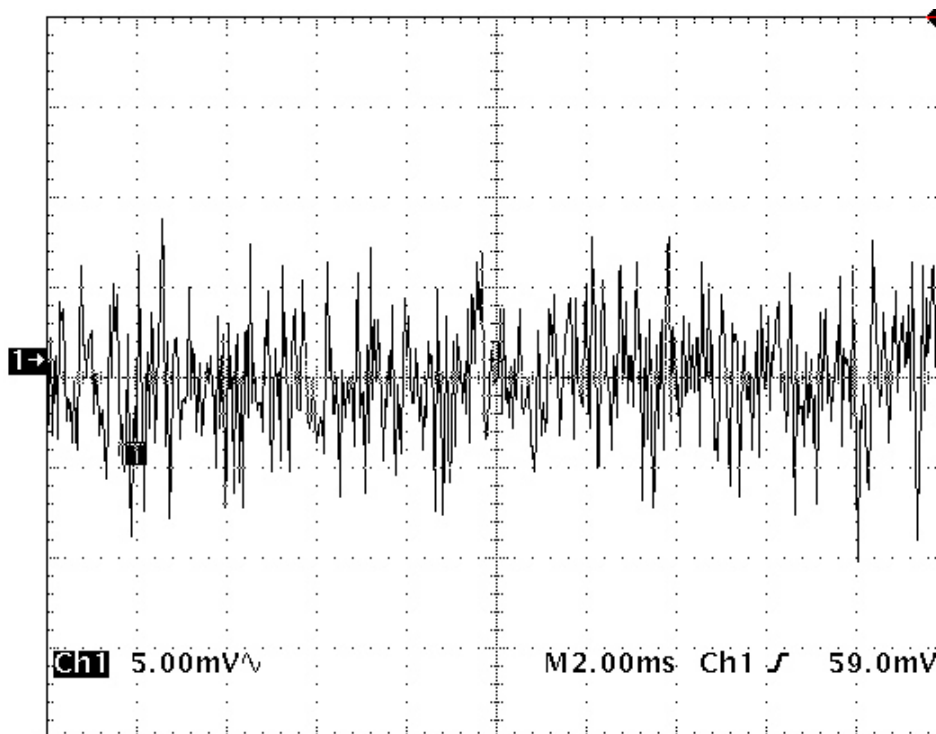

Figure 1. Raw Output

NOISE FILTERING TECHNIQUES AND CONSIDERATIONS

For mitigating the effects of this sensor noise, two general approaches are effective, low pass filtering with hardware, and low pass filtering with software. When filtering with hard-

ware, a low-pass RC filter with a cutoff frequency of 650 Hz is recommended. A 750 ohm resistor and a 0.33 μF capacitor have been determined to give the best results (see Figure 2) since the 750 ohm series impedance is low enough for most A/D converters.

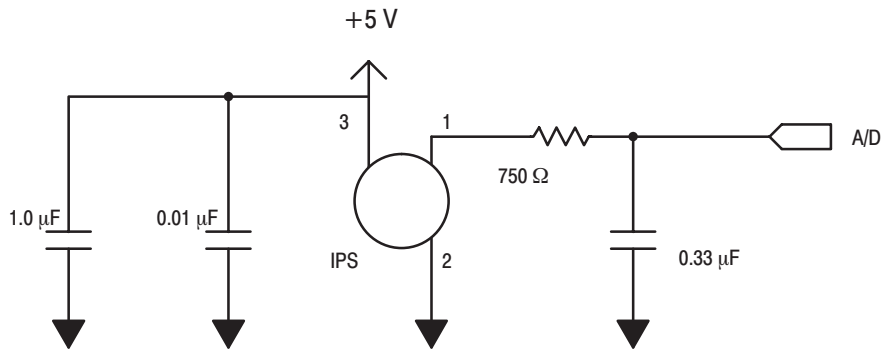

Figure 2. Integrated Pressure Sensor with RC LP Filter to Filter Out Noise

This filter has been tested with an HC05 microcontroller which has a successive approximation A/D converter. Successive approximation A/D's are generally compatible with the DC source impedance of the filter in Figure 2. Results are shown in Figure 4.

Some A/D's will not work well with the source impedance of a single pole RC filter. Please consult your A/D converter tech-

nical data sheet if input impedance is a concern. In applications where the A/D converter is sensitive to high source impedance, a buffer should be used. The integrated pressure sensor has a rail-to-rail output swing, which dictates that a rail-to-rail operational amplifier (op amp) should be used to avoid saturating the buffer. A rail-to-rail input and output op amp works well for this purpose (see Figure 3).

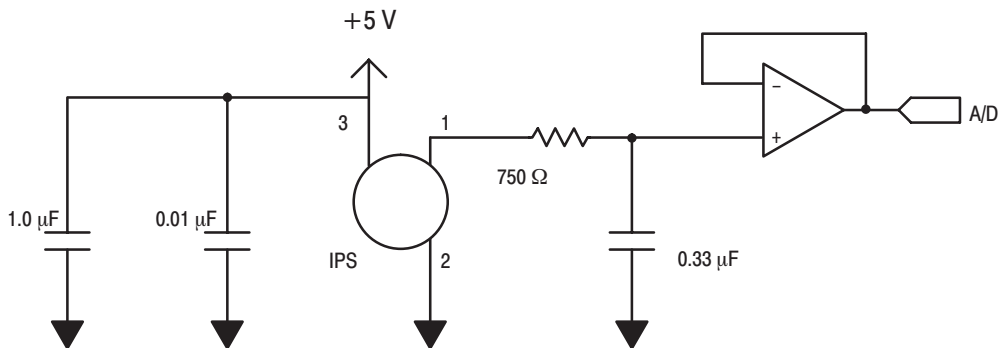

Figure 3. Use a Rail-to-Rail Buffer to Reduce Output Impedance of RC Filter

Averaging is also effective for filtering sensor noise. Averaging is a form of low pass filtering in software. A rolling average of 8 to 64 samples will clean up most of the noise. A 10 sample average reduces the noise to about 2.5 mV peak to peak and a 64 sample average reduces the noise to about 1 mV peak to peak (see Figures 5 and 6).

This method is simple and requires no external components. However, it does require RAM for data storage, extra computation cycles and code. In applications where the microcontroller is resource limited or pressure is changing relatively rapidly, averaging alone may not be the best solution. In these situations, a combination of RC filtering and a limited

number of samples gives the best results. For example, a rolling average of 4 samples combined with the RC filter in Figure 2 results in a noise output on the order of 1 mV peak to peak.

Another important consideration is that the incremental effectiveness of averaging tends to fall off as the number of samples is increased. In other words, the signal-to-noise (S/N) ratio goes up more slowly than the number of samples. To be more precise, the S/N ratio improves as the square root of the number of samples is increased. For example, increasing the number of samples from 10, in Figure 5, to 64, in Figure 6, reduced noise by a factor of 2.5.

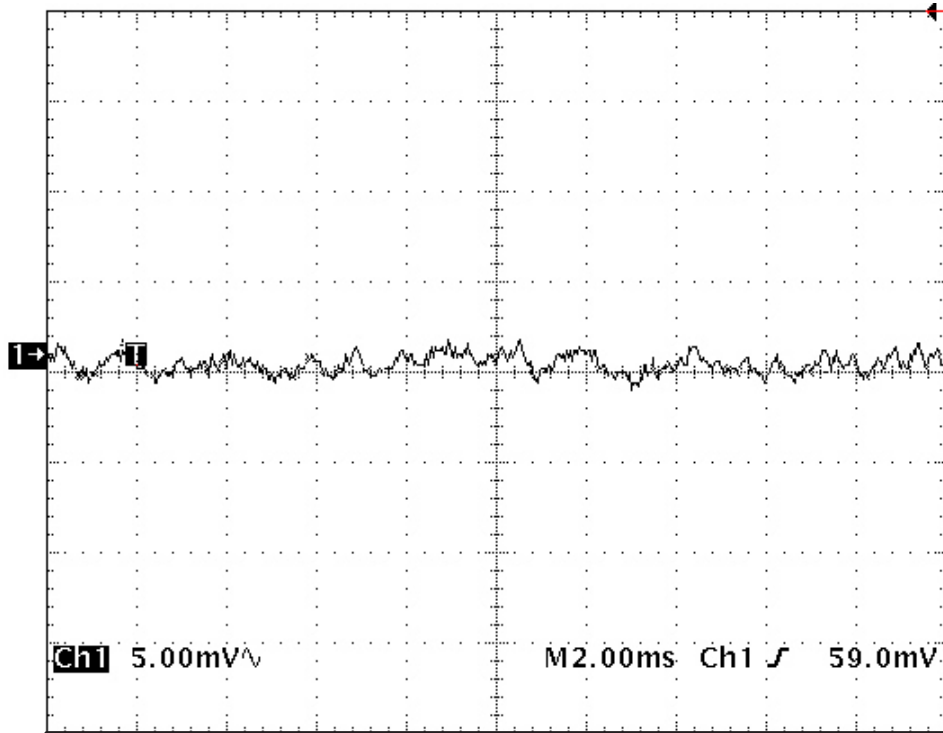

Figure 4. Output After Low Pass Filtering

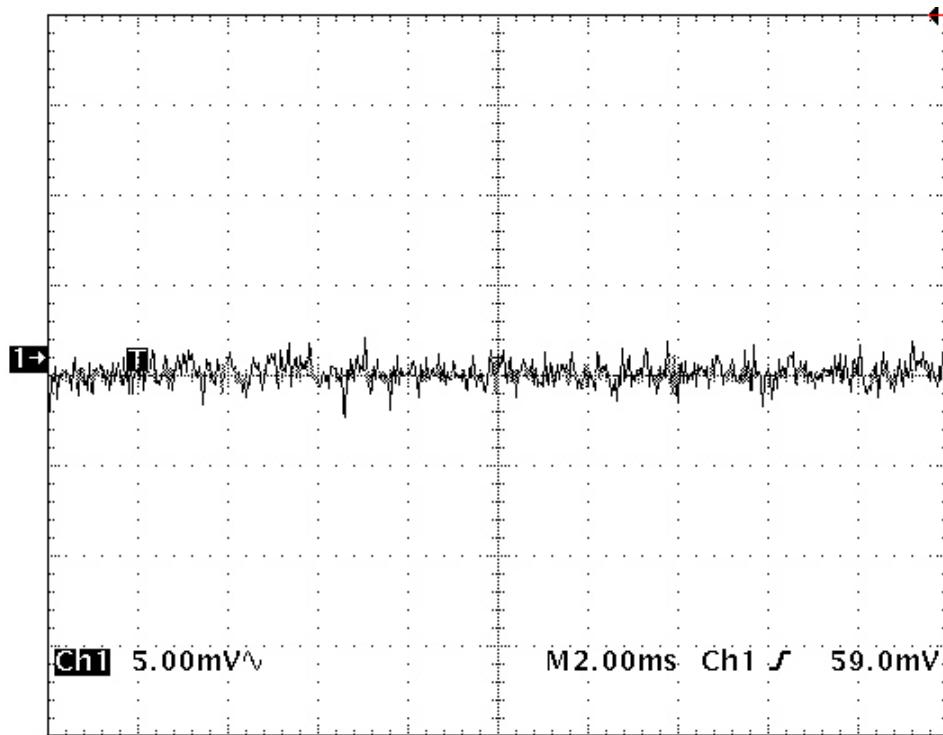

Figure 5. Output with 10 Averaged Samples

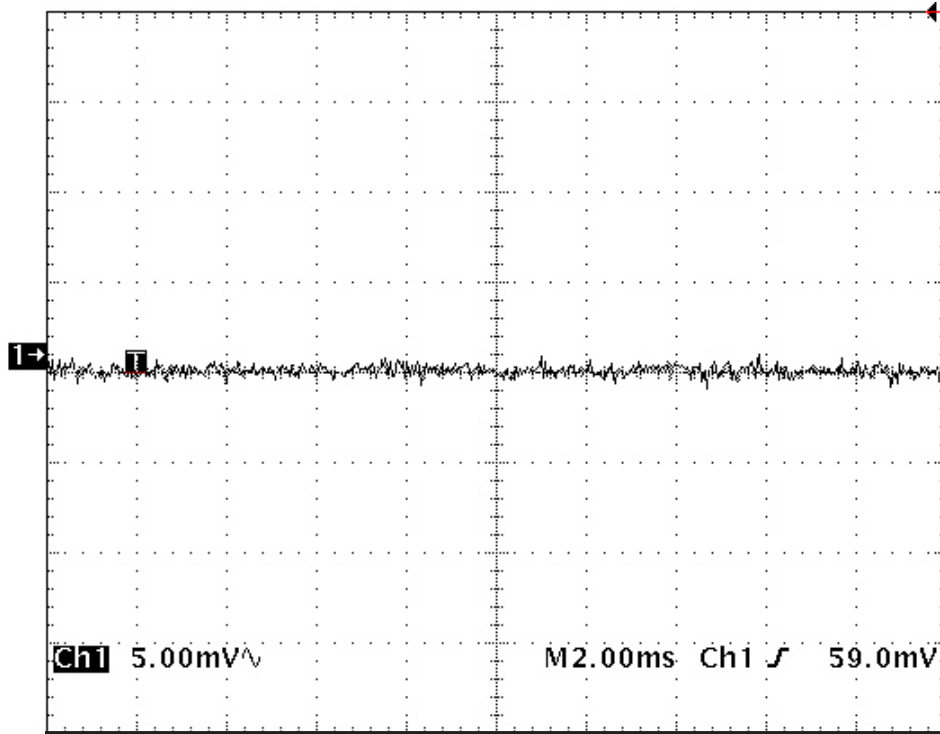

Figure 6. Output with 64 Averaged Samples

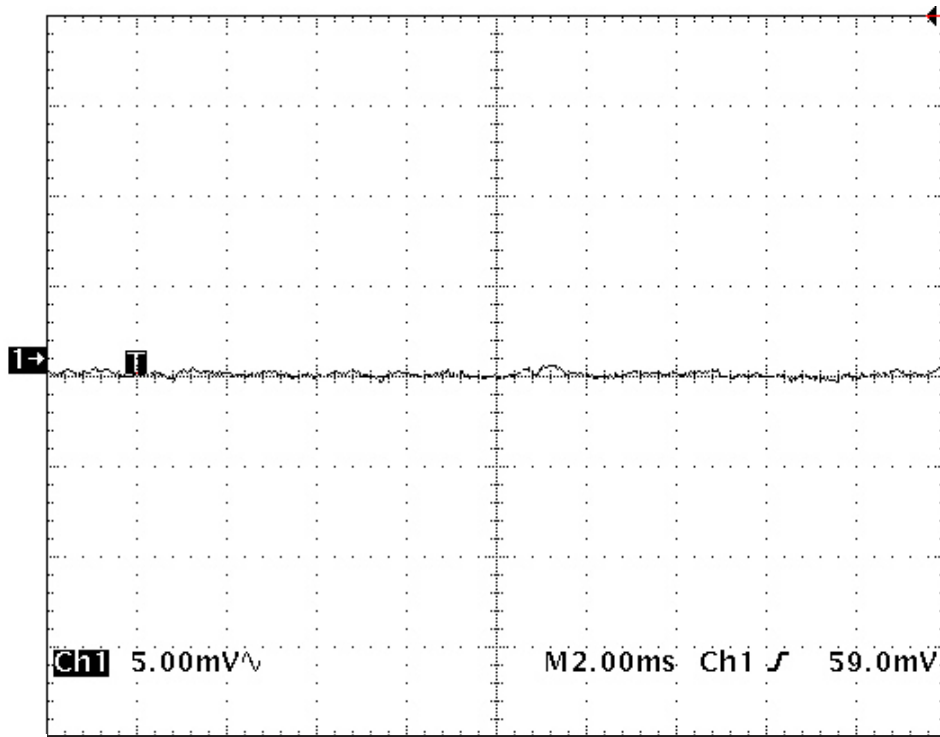

Figure 7. Filtered Sensor Output and Averaged Over 10 Samples

POWER SUPPLY

Since the sensor output is ratiometric with the supply voltage, any variation in supply voltage will also proportionally appear at the output of the sensor. The integrated pressure sensor is designed, characterized and trimmed to be powered with a 5 V \pm 5% power supply which can supply the maximum 10 mA current requirement of the sensor. Powering the integrated sensor at another voltage than specified is not recommended because the offset, temperature coefficient of offset (TCO) and temperature coefficient of span (TCS) trim will be invalidated and will affect the sensor accuracy.

From a noise point of view, adequate de-coupling is important. A 0.33 μ F to 1.0 μ F ceramic capacitor in parallel with a 0.01 μ F ceramic capacitor works well for this purpose. Also, with respect to noise, it is preferable to use a linear regulator such as an MC78L05 rather than a relatively more noisy switching power supply 5 volt output. An additional consideration is that the power to the sensor and the A/D voltage reference should be tied to the same supply. Doing this takes advantage of the sensor output ratiometricity. Since the A/D resolution is also ratiometric to its reference voltage, variations in supply voltage will be canceled by the system.

LAYOUT OPTIMIZATION

In mixed analog and digital systems, layout is a critical part of the total design. Often, getting a system to work properly depends as much on layout as on the circuit design. The following discussion covers some general layout principles, digital section layout and analog section layout.

General Principles:

There are several general layout principles that are important in mixed systems. They can be described as five rules:

Rule 1: Minimize Loop Areas. This is a general principle that applies to both analog and digital circuits. Loops are antennas. At noise sensitive inputs, the area enclosed by an incoming signal path and its return is proportional to the amount of noise picked up by the input. At digital output ports, the amount of noise that is radiated is also proportional to loop area.

Rule 2: Cancel fields by running equal currents that flow in opposite directions as close as possible to each other. If two equal currents flow in opposite directions, the resulting electromagnetic fields will cancel as the two currents are brought infinitely close together. In printed circuit board layout, this situation can be approximated by running signals and their returns along the same path but on different layers. Field cancellation is not perfect due to the finite physical separation, but is sufficient to warrant serious attention in critical paths. Looked at from a different perspective, this is another way of looking at Rule # 1, i.e., minimize loop areas.

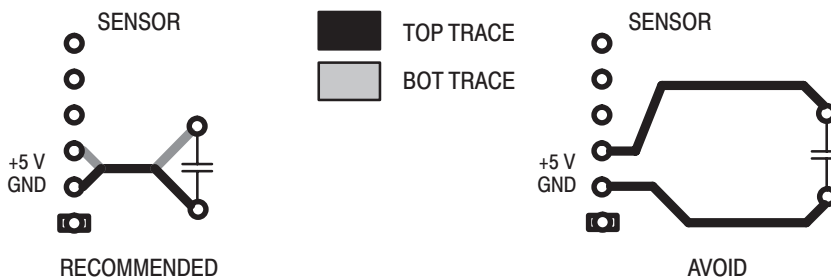

Figure 8. Minimizing Loop Areas

Rule 3: On traces that carry high speed signals avoid 90 degree angles, including “T” connections. If you think of high speed signals in terms of wavefronts moving down a trace, the reason for avoiding 90 degree angles is simple. To a high speed wavefront, a 90 degree angle is a discontinuity that produces unwanted reflections. From a practical point of view, 90 degree turns on a single trace are easy to avoid by using two 45 degree angles or a curve. Where two traces come together to form a “T” connection, adding some material to cut across the right angles accomplishes the same thing.

Rule 4: Connect signal circuit grounds to power grounds at only one point. The reason for this constraint is that transient voltage drops along the power grounds can be substantial, due to high values of di/dt flowing through finite inductance. If signal processing circuit returns are connected to power ground at multiple points, then these transients will show up as return voltage differences at different points in the signal processing circuitry. Since signal processing circuitry seldom has the noise immunity to handle power ground transients, it is generally necessary to tie signal ground to power ground at only one point.

Rule 5: Use ground planes selectively. Although ground planes are highly beneficial when used with digital circuitry, in the analog world they are better used selectively. A single ground plane on an analog board puts parasitic capacitance in places where it is not desired, such as at the inverting inputs of op amps. Ground planes also limit efforts to take advantage of field cancellation, since the return is distributed.

ANALOG LAYOUT

In analog systems, both minimizing loop areas and field cancellation are useful design techniques. Field cancellation is applicable to power and ground traces, where currents are equal and opposite. Running these two traces directly over each other provides field cancellation for unwanted noise, and minimum loop area.

Figure 8 illustrates the difference between a power supply de-coupling loop that has been routed correctly and one that has not. In this figure, the circles represent pads, the schematic symbols show the components that are connected to the pads, and the routing layers are shown as dark lines (top trace) or grey lines (bottom trace). Note that by routing the two traces one over the other that the critical loop area is minimized. In addition, it is important to keep de-coupling capacitors close to active devices such as MPX5000-series sensors and operational amplifiers. As a rule of thumb, when 50 mil ground and Vcc traces are used, it is not advisable to have more than 1 inch between a de-coupling capacitor and the active device that it is intended to be de-coupled.

AN1646

For similar reasons it is desirable to run sensor output signals and their return traces as close to each other as possible. Minimizing this loop area will minimize the amount of external noise that is picked up by making electrical connections to the sensor.

DIGITAL LAYOUT

The primary layout issue with digital circuits is ground partitioning. A good place to start is with the architecture that is shown in Figure 9. This architecture has several key attributes. Analog ground and digital ground are both separate and distinct from each other, and come together at only one point. For analog ground it is preferable to make the one point as close as possible to the analog to digital converter's ground reference (V_{REFL}). The power source ground connection should be as close as possible to the microcontroller's power supply return (V_{SS}). Note also that the path from V_{REFL} to V_{SS} is isolated from the rest of digital ground until it approaches V_{SS} .

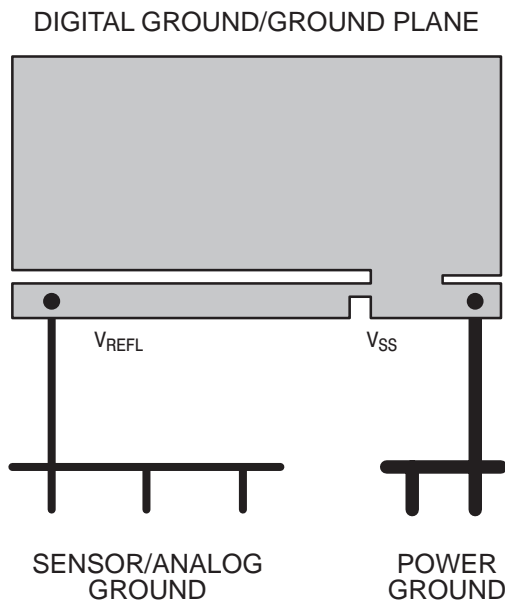

Figure 9. Ground Partitioning

In addition to grounding, the digital portion of a system benefits from attention to avoiding 90 degree angles, since there are generally a lot of high speed signals on the digital portion of the board. Routing with 45 degree angles or curves minimizes unwanted reflections, which increases noise immu-

nity. Single traces are easy, two forty five degree angles or a curve easily accomplish a 90 degree turn. It is just as important to avoid 90 degree angles in T connections. Figure 10 illustrates correct versus incorrect routing for both cases.

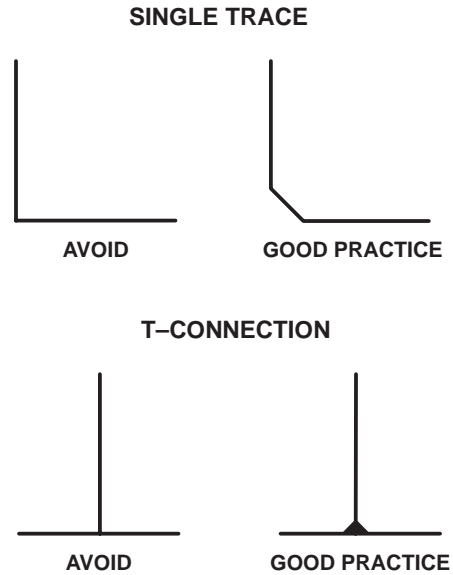

Figure 10. 90 Degree Angles

CONCLUSION

Piezo-resistive pressure sensors produce small amounts of noise that can easily be filtered out with several methods. These methods are low pass filtering with an RC filter, averaging or a combination of both which can be implemented with minimal hardware cost.

In a mixed sensor system, noise can be further reduced by following recommended power supply, grounding and layout techniques.

REFERENCES

- [1] AN1626 Noise Management in Motor Drives, Warren Schultz, Motorola, Inc.
- [2] Noise Reduction Techniques In Electronic Systems 2nd Edition, Henry W. Ott, John Wiley & Sons.
- [3] Noise: Comparing Integrated Pressure Sensors and Op Amps, Ira Basket, Motorola Sensor Products Division internal paper.

Motorola reserves the right to make changes without further notice to any products herein. Motorola makes no warranty, representation or guarantee regarding the suitability of its products for any particular purpose, nor does Motorola assume any liability arising out of the application or use of any product or circuit, and specifically disclaims any and all liability, including without limitation consequential or incidental damages. "Typical" parameters which may be provided in Motorola data sheets and/or specifications can and do vary in different applications and actual performance may vary over time. All operating parameters, including "Typicals" must be validated for each customer application by customer's technical experts. Motorola does not convey any license under its patent rights nor the rights of others. Motorola products are not designed, intended, or authorized for use as components in systems intended for surgical implant into the body, or other applications intended to support or sustain life, or for any other application in which the failure of the Motorola product could create a situation where personal injury or death may occur. Should Buyer purchase or use Motorola products for any such unintended or unauthorized application, Buyer shall indemnify and hold Motorola and its officers, employees, subsidiaries, affiliates, and distributors harmless against all claims, costs, damages, and expenses, and reasonable attorney fees arising out of, directly or indirectly, any claim of personal injury or death associated with such unintended or unauthorized use, even if such claim alleges that Motorola was negligent regarding the design or manufacture of the part. Motorola and  are registered trademarks of Motorola, Inc. Motorola, Inc. is an Equal Opportunity/Affirmative Action Employer.

How to reach us:

USA/EUROPE/Locations Not Listed: Motorola Literature Distribution; P.O. Box 5405, Denver, Colorado 80217. 1-303-675-2140 or 1-800-441-2447

JAPAN: Motorola Japan Ltd.; SPS, Technical Information Center, 3-20-1, Minami-Azabu. Minato-ku, Tokyo 106-8573 Japan. 81-3-3440-3569

ASIA/PACIFIC: Motorola Semiconductors H.K. Ltd.; Silicon Harbour Centre, 2 Dai King Street, Tai Po Industrial Estate, Tai Po, N.T., Hong Kong. 852-26668334

Technical Information Center: 1-800-521-6274

HOME PAGE: <http://www.motorola.com/semiconductors/>

**MOTOROLA**